

User Manual
8880 Series Fault Finding & Locating Kit



Model 8880PLS STAFF



Model 8880PLS HVDFE

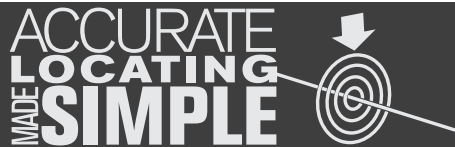

Table of Contents

GENERAL INFORMATION

Introduction	2
Warnings	2
Prepare for Use	2
Transmitter Controls and Indicators	3-4
Selecting the Tracing Signal	5
Direct Connect	6
Flexicoupler Connection	6
Inductive Connection	7
Blind Search	7
Receiver Controls and Indicators	8-9
Absolute Signal Strength	9
Gain Change Indication	9
Locating the Cable or Pipe	10
Selecting the Locating Mode	10
Peak Locating Mode	10-11
Null Locating Mode	11
Passive 50/60 Hz Locating	13
Push Button Depth	13
Depth Measurement 45 Degree Angle Method	14
Tilted Magnetic Field Identification	14
STAFF Controls	15
Fault Locating	16
Signal Return Through an Insulated Fault	16
Ground Return Probe	16
Ground Return Probe Insertion	16
Ground Return Probe Fault Locating	17
GRP Receiver Meter Response with Distance	17
Faults Beneath Paved Surfaces	18
8880 Transmitter Specifications	19
8879 Receiver Specifications	20
STAFF Receiver Specifications	20
Part List	21
Warranty	21

Introduction Congratulations on the purchase of your new 8880 STAFF or 8880 HVDFE Locator. The 8880 Series Locator is specially designed to detect buried utilities. This device may detect buried power cables, CATV cables, gas and water pipes, sewer lines, telephone cables, fiber optic cables with sheath, sondes, inspection camera transmitters.

The TRANSMITTER emits a signal. The RECEIVER detects the signal. You can locate the relative position of the buried utility, sonde or camera by following the tracing signal.

WARNING



Electric shock hazard:

- Follow appropriate safety procedure and your companies policies.
- Tool is designed to detect electromagnetic field emitted from cables and buried metallic utilities. **There are buried cables, pipes, and utilities this instrument CANNOT detect.**
- LOCATING is not an exact science. **The only certain way to be sure of the existence, location, or depth of buried utilities is to carefully expose (dig up) the utility.**
- **De-energize any circuits in or around the work area.**
- Do not expose tool to rain or moisture.
- Use tool only for intended purpose as described in this manual
- Turn off transmitter before touching test lead or any un-insulated conductor.
- Do not connect to live voltage or active utility lines.

Failure to observe these warnings could result in severe injury or death.

DISCLAIMER OF LIABILITY

RYCOM INSTRUMENTS, INC SHALL NOT BE LIABLE TO DISTRIBUTOR, RESELLER, OR ANY OTHER PERSON FOR ANY INCIDENTAL, INDIRECT, SPECIAL, EXEMPLARY OR CONSEQUENTIAL DAMAGES, OR INJURY OF ANY TYPE WHATSOEVER, AND CAUSED DIRECTLY OR INDIRECTLY BY PRODUCTS SOLD OR SUPPLIED BY RYCOM INSTRUMENTS, INC.

Prepare for Use

Unpack your new **8880** Directional Fault Finder and Locator . Make sure there is no shipping damage and all the parts are included.

Locate the battery compartment on the back of the "head" of the RECEIVER. Open the compartment using a phillips screwdriver. Install the six Duracell® "C" batteries as marked.

Locate the battery compartment inside the TRANSMITTER. Remove the battery compartment door. Connect the loose battery wire to the battery terminal.

Locate the battery compartment on the back of the top tube of the STAFF. The cap unscrews counterclockwise. Insert the 6 "AA" batteries according to the label with the corresponding terminal (+/-) facing up.

Note: For longer battery life and reliable operation under adverse conditions, use only Duracell® alkaline batteries.

8880PLS Transmitter Series

Transmitter Controls and Indicators

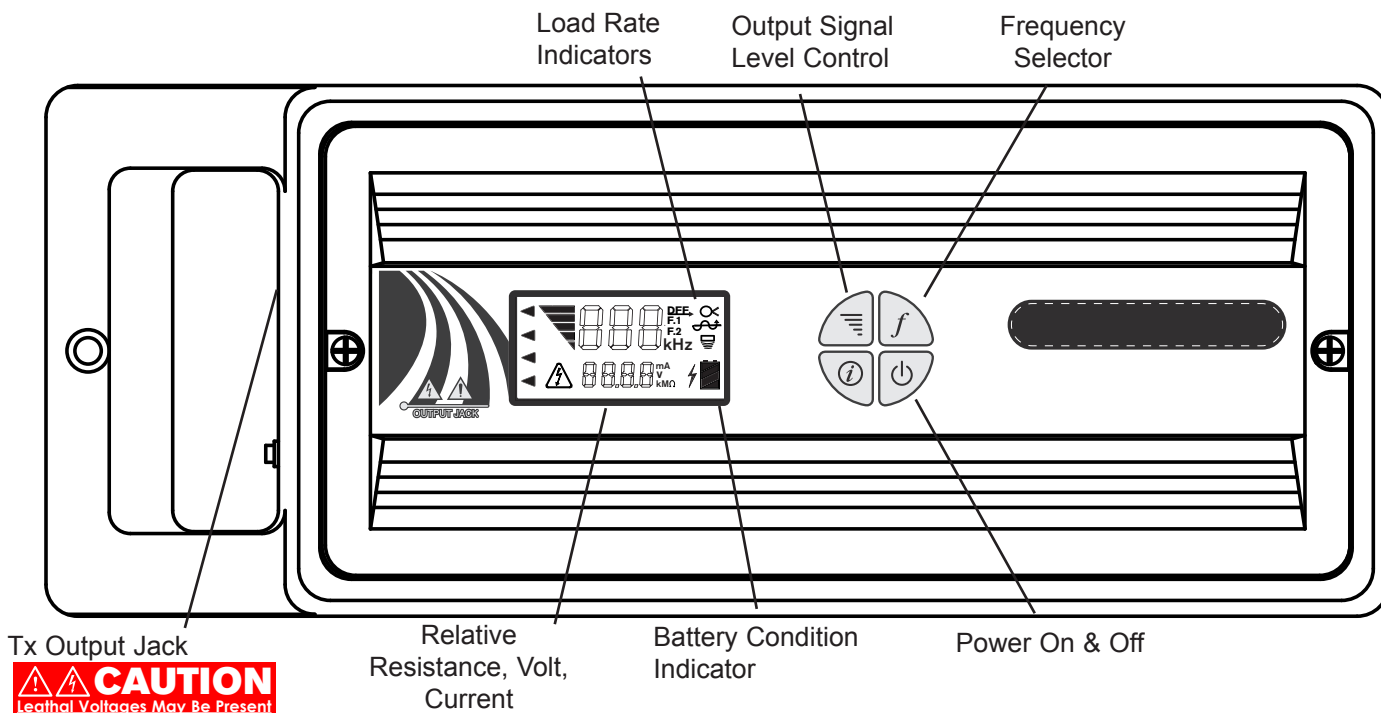

TX OUTPUT JACK

The RED/BLACK CORD, Coupler and FLEXICOUPLER connects here to create a circuit on the buried utility.

FREQUENCY SELECTOR

The 82 kHz reading indicates that the 82 kHz frequency is in use. This frequency is the higher of the four. The 82 kHz frequency is often used to locate sharp corners in cables or pipes and is capable of jumping disconnected shield bonds or grounds. The 815 Hz reading indicates that the 815 Hz frequency is in use. The 815 Hz is the lower frequency. It is less susceptible to locating errors caused by adjacent cables or pipes. Also, by using the 815 Hz frequency, the locating range is greater. The 8 kHz and 33kHz are mid-range frequencies used when the 815Hz is too weak and the 82 kHz is bleeding off to easily.

To access the **DFF** Fault Finding transmit signal, press and hold the frequency key for 10 seconds. When released the unit will be in fault finding mode. Pressing the frequency key again or shutting off the unit will change the setting off of the DFF signal.

LOAD RATE INDICATOR

The Load Rate Indicator symbol flashes to indicate the output circuit impedance. When the indicator blinks 4 times per second, it is indicating a nearly short circuit. When the indicator blinks 1 time every 3 seconds, it is indicating a nearly open circuit.

OUTPUT SIGNAL LEVEL CONTROL

The OUTPUT SIGNAL LEVEL CONTROL adjusts the power output from the TRANSMITTER. There are 5 selections from low to high. **Note: A 6th selection is available** by holding down the Power Output button for 5 Seconds this allows for loading without impedance matching.

SIGNAL INFORMATION SELECTOR

The unit can display the relative resistance, current and voltage of the transmitted signal. The resistance is based on the feed back from the selected frequency and is not an actual impedance meter. The selections can be toggled by pressing the SIGNAL INFORMATION button.

AC Resistance Indications

NUMBER OF BLINKS	IMPEDANCE Ω
4 blinks per second	5 Ω -15 Ω circuit
2 blinks per second	15 Ω -100 Ω circuit
1 blink per second	100 Ω - 400 Ω circuit
1 blink every 2 seconds	400 Ω - 1800 Ω circuit
1 blink every 3 seconds	1800 Ω - open circuit

*Load Values for Direct Connection

Note: When the load indicator does not blink in the 815 Hz mode, this indicates the RED/BLACK CORD needs to be plugged in.

Transmitter Rechargeable Battery Option

If the 8880 TRANSMITTER has a rechargeable battery, the battery cover will extend past the main TRANSMITTER housing shell by approximately half an inch. The CHARGER PLUG is located near the inner wall of the carrying handle on the TRANSMITTER housing. The rechargeable battery is a 12V 7 amp/hr sealed lead acid battery. The battery may be replaced by removing the back cover and the four nuts on each side of the battery bracket. Once the bracket is removed, the two red/black wires can be disconnected from the battery terminals by pulling the forth-of-an-inch spade connector off.

An automatic shut down circuit protects the lead acid battery from excessive discharge. This circuit trips an internal shutoff system that activates when the battery voltage discharges down to 8.2V. The auto shutoff circuit can be reset by turning the power switch off. The LOW BAT icon located on the LED display turns on when the battery discharges down to 10.5V. The time between a LOW BAT indication and an auto shutoff, will vary from 30 minutes to 15 minutes depending on the charge level of the battery and when the LOW BAT condition occurs. Also when the LOW BAT icon is activated, the output will cycle every 20 seconds on the RECEIVER to inform the user a LOW BAT condition is present.

Note: Do not reset the TX after the auto shutoff has switched the TX off. Doing so will drain the battery to the point where it will not accept a charge.



Sealed lead acid batteries should be disposed of in accordance with your companies policies, and/or city, state, or federal regulations and guidelines.

Recharging the Battery

AC Charger A discharged battery can be fully charged in 24 hours or less with the use of the AC CHARGER. A partially discharged battery should be charged for a shorter time. When charging the battery with the AC CHARGER, the TRANSMITTER power switch must be in the OFF position. Do not attempt to power the TRANSMITTER with the AC CHARGER. Possible damage could result to the charger if the switch is on when attempting to charge the battery with the AC CHARGER.

Selecting the Tracing Signal

The choice of 815 Hz, 8 kHz, 33 kHz or 82 kHz Frequency is dependent on the conditions of the locate.

The 815 Hz, 8 kHz 33 kHz and 82 kHz signals each have their advantages. It is recommended to begin by using the 815 Hz signal, and continue as long as you are confident in the results. If the signal is very weak try to adjust the connection or grounding. If there is no improvement in signal then try 8 kHz. Repeat adjustments of ground and connection point again until switching to 82 kHz.

815 Hz (lower frequency) signal is usually preferred to the 8 kHz (mid-range frequency) and 82 kHz (high frequency) signal, because it is much less susceptible to locating errors caused by nearby cables or pipes. The 815 Hz locating range is also much longer than the 82 kHz signal. The 815 Hz signal will not travel well through disconnected shield bonds or insulated pipe bushing.

8 kHz and 33 kHz takes the best of both high and low frequency. These mid range frequencies are not very susceptible to bleed off or coupling, but it can jump impedance on the utility better than the 815 Hz. It is still best to use 815 Hz, but 8 kHz and 33 kHz are some of the most common frequencies used to locate coaxial cable and telecom pairs.

The 82 kHz (higher frequency) is sometimes better than the 815 Hz (lower frequency) for locating sharp corners in cables or pipes. The 82 kHz signal is also better for "jumping" disconnected shield bonds or grounds, or tracing signal may indicate one of these characteristics. The locating range is quite short for the 82 kHz signal so the TRANSMITTER must be repositioned more often during the tracing operation. This FREQUENCY is also useful for applying a signal using the FLEXICOUPLER OR THE HARD COUPLER.

Direct Connection



CAUTION DO NOT CONNECT TO LIVE OR ENERGIZED POWER CABLES



CAUTION TURN OFF TRANSMITTER BEFORE TOUCHING, CONNECTING OR DISCONNECTING TEST CORDS

Direct Connection is the most reliable method of signal application. This method is relatively free of interference. The greatest amount of signal strength can be achieved by this method. Low, mid, and high frequency may be used. The far end of the utility must be grounded.

Connect the RED TEST CORD to an existing ground point or an exposed metallic section of the utility. Place the GROUND ROD approximately 10 feet from this point, at an angle of 90° to the buried cable or pipe. Push the GROUND ROD into the ground 8 to 10 inches. Connect the BLACK TEST CORD to the GROUND ROD.

Plug the RED/BLACK TEST CORD into the TX OUTPUT JACK. Press the FREQUENCY Button for 815 Hz, 8 kHz, 33kHz or 82 kHz. The Power Output Indicator and the Frequency light of the chosen frequency will light up.

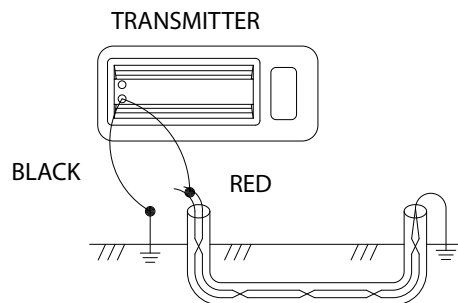

Coupler & Flexicoupler Connection

The optional FLEXICOUPLER and HARD COUPLER are very easy to use, and services do not have to be interrupted. The operation range is shorter than for Direct Connection methods. The tracing signal can be affected by neighboring cables and pipes. The RED/BLACK TEST CORD or the GROUND ROD are not needed for this method.

Successful COUPLER operation requires an insulated conductor that is grounded on both near and far ends.

Loop the FLEXICOUPLER around the cable and connect the two ends, or clamp the HARD COUPLER around the cable. It is important to connect the COUPLER around the cable needing to be traced. Connect the COUPLER around the wire closer to the outgoing cable not near the system ground. The result will be a stronger signal. By connecting near the grounding, the range will also be shorter, and difficulty may arise determining one cable from another.

Plug the COUPLER TEST CORD into the TX OUTPUT JACK. Always use the 82 kHz FREQUENCY on the RECEIVER and the TRANSMITTER.

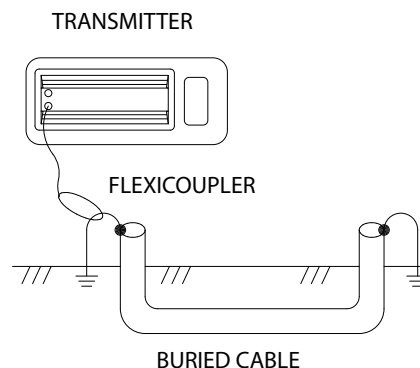

Inductive Connection

This method is convenient to use, and services are not interrupted. No test cords or connections are needed. The cable or pipe must have good insulation or non-conductive coating, or the operating range will be short.

Turn the TRANSMITTER ON. Press the 82 kHz button. Place TRANSMITTER ON ITS SIDE as close as possible to the path of the cable or pipe. Align the ARROWS on the SIDE OF THE TRANSMITTER in line with the cable or pipe. First, locate the broad TRANSMITTER Null, then move toward the expected cable path while looking for the signal carried by the cable.

Start tracing the path with the RECEIVER 25 feet from the TRANSMITTER. Search in the 90° zone as shown above. Locate the cable or pipe, and follow the path. If the signal becomes weak, move the TRANSMITTER to a point 25 feet behind the last strong signal, and continue searching.

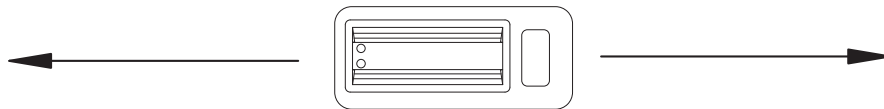

Blind Search

The Blind Search locating techniques is used if the operator is not aware if a buried utility exists. Two people are needed for this technique. The TRANSMITTER and the RECEIVER are Held 25 feet away from each other. Each operator walks at the same speed keeping a distance of 25 feet from each other. When the receiver gives an audio response, then a buried utility is present between the RECEIVER and the TRANSMITTER.

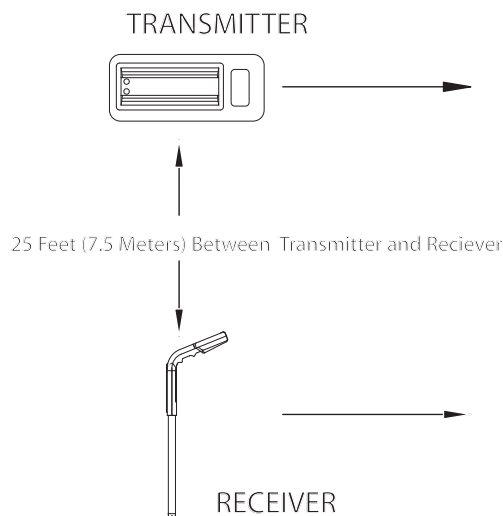

8880 Receiver Controls and Indicators

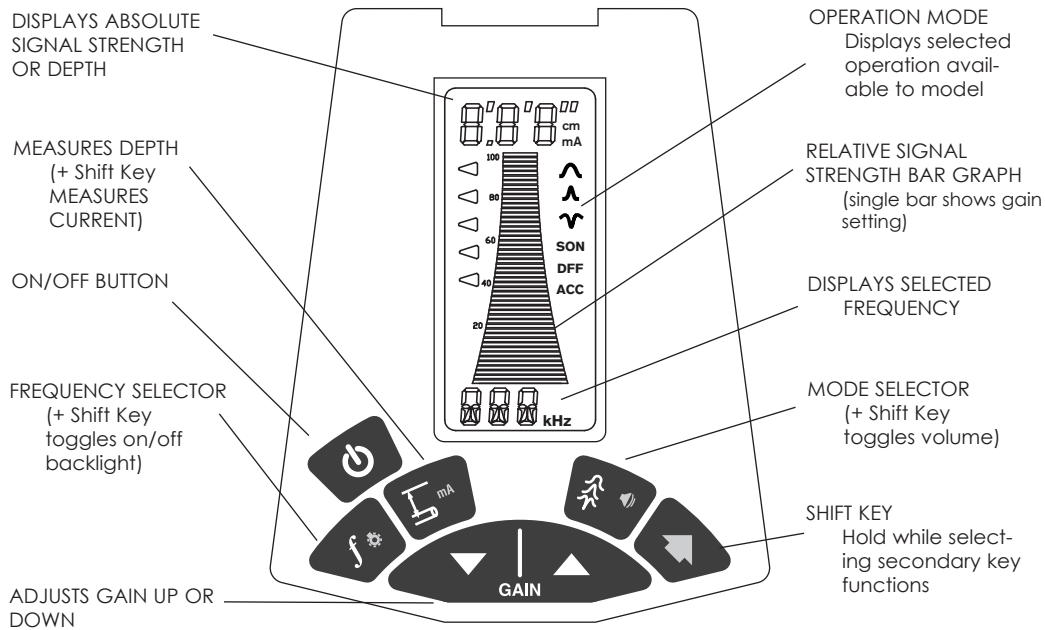

ON/OFF Button

The unit will load settings from previous usage.

Note: Automatic shut off after 10 minute of no use.

FREQUENCY Button

Toggles through available active and passive frequencies (model specific). 8880 - 82 kHz, 33KHZ, 8 kHz, 815 Hz, 50/60 Hz and RF. To change the Depth Measurement from English to Mertic, hold the Frequency Key for ten seconds.

MODE Button

Toggle through available mode (model specific).

8880 - PEAK, PINPOINT PEAK, NULL, ACC, DFF and SONDE locating modes.

DEPTH Button

DEPTH function will first momentarily display the depth mode (Line [LIN] or Sonde [SON]) and then display depth measurement.

GAIN Button (Up or Down)

Adjusts the gain up or down. If the signal strength shows as " --- " on the display, pressing the GAIN will automatically adjust to 85% on the scale display.

CURRENT (SHIFT Button + DEPTH Button)

Measure the relative amount of transmitted current.

VOLUME (SHIFT Button + MODE Button)

Toggle volume through High, Medium, Low and Off.

BACKLIGHT (SHIFT Button + FREQUENCY Button)

Hold the SHIFT Key and press the CURRENT key to toggle on and off the back light.

LOW BATTERY

The 8880 Locator will indicate low battery condition by displaying "LO BAT" in the three digit Signal Strength Display at the top of the LCD screen.

Absolute Signal Strength

The 8880 RECEIVER provides the operator with a direct measurement of the RECEIVER'S signal strength. The measurement is displayed with three numerical digits (ex: **485**) located at the top of the LCD display. The measurement range is from 0 to 999 indicating a very weak signal (0) to a very strong signal (999). Absolute Signal Strength is independent of the GAIN setting or meter reading. It gives the operator information about the actual amount of signal being radiated from the conductor and received by the RECEIVER.

Measuring Absolute Signal Strength at any time is done by reading the number at the top of the LCD display. The Absolute Signal Strength will not be displayed if the meter reading is too high or too low. Adjust the GAIN to move the meter reading to mid-scale. The numerical display will change from '---' to a valid measurement.

Absolute Signal Strength measurements are more sensitive to signal changes than the meter display. PEAKS and NULLS can be more precisely pin-pointed. This measurement can also be used to monitor signal loss as the conductor is being traced.

Gain Change Indication

The GAIN up and down buttons are used to increase and decrease the gain in small amounts. If the meter reading is very low, pressing the GAIN up button will center the meter reading to 75%-scale. Likewise, if the meter reading is very high, pressing the GAIN down button will center the meter reading to mid-scale.

When the GAIN is too high three dashes will appear in the Absolute Signal Strength window (---) and the tone will change to a high frequency pulse. This is to indicate the need to gain down.

Passive 50/60 Hz Locating

The 8880 RECEIVER is capable of locating power utility frequencies. This MODE is useful for locating underground primary and secondary power utilities. In certain circumstances, this MODE will also locate water pipes, sewer lines, cable television, and telephone. The reason is that common electrical grounds are sometimes found among these various utilities. Select the 50/60~ (Hz) frequency on the RECEIVER. Select PEAK mode. Locate the conductor using the PEAK mode.

This method is useful because of its speed and convenience. Start at a known reference point and keep in mind that other conductors in the area may produce this same locating signal.

The TRANSMITTER is not required to locate in this mode.

Passive Radio Frequency Locating

The 8880 RECEIVER is capable of passively locating metallic utilities where radio frequencies have coupled to the utility. This mode is useful for sweeping a green area for utilities. In certain circumstances, this mode will locate water pipes, cable television, gas lines and telephone. This locating option does not always detect buried utilities even when radio frequencies are present. This method is useful because of its speed and convenience. Start at a known reference point and keep in mind that other conductors in the area may produce this same locating signal.

The TRANSMITTER is not required to locate in this mode.

Cathodic Protection Frequency

The 8880HVDFP CP RECEIVER is capable of locating the rectified signal of Cathodically Protected utilities at 120Hz. This method is useful because of its speed and convenience. Start at a known reference point and keep in mind that other conductors in the area may produce this same locating signal.

The TRANSMITTER is not required to locate in this mode.

Locating the Cable or Pipe

Make sure the TRANSMITTER is connected and in the ON position. Then move approximately 15 feet (4.5 meters) away from the TRANSMITTER along the path. (Move about 25 feet (7.5 meters) for the Inductive search mode.)

Hold the RECEIVER so that you can see the LCD bar graph and controls easily. Make sure the RECEIVER and the TRANSMITTER FREQUENCY are both set for the same FREQUENCY, either 815 Hz (lower), 8 kHz, 33kHz or 82 kHz (higher). Or select the passive locating mode which do not require the transmitter

Selecting the Locating Mode (Peak or Null)

Press the MODE button to select the desired Peak or Null locating method.

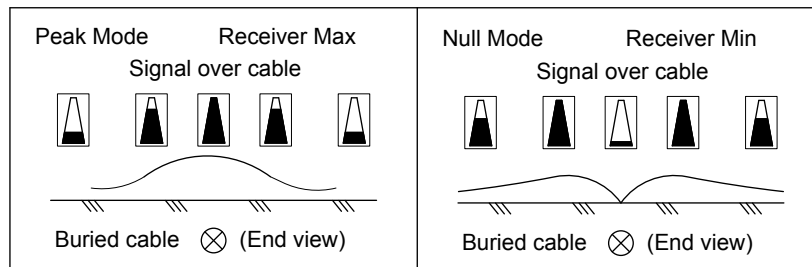

Peak Mode Locating

Keep the RECEIVER in a vertical position. Move the RECEIVER left to right across the path. When the RECEIVER is directly above the cable or pipe, rotate the RECEIVER for a maximum signal. As you move the RECEIVER away from the cable path, the meter reading (and audio frequency response) will drop off.

If you rotate the RECEIVER while over the cable, a sharp NULL will identify the cable's direction. It is aligned with the flat side of the RECEIVER.

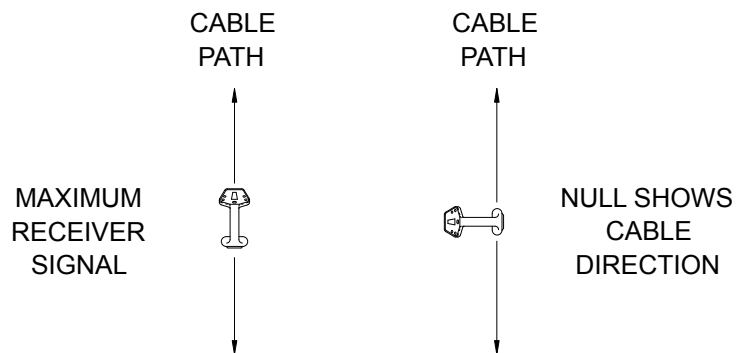

Peak Mode Locating Continued

Trace the path by walking away from the TRANSMITTER at a moderate pace. Move the RECEIVER to the left and right while walking, following the PEAK indications.

As you trace the path, the PEAK meter reading may slowly fade as you move away from the TRANSMITTER. Press and release the GAIN buttons as needed to compensate for changes in level (higher or lower). One of the following may occur:

- a) a junction where the signal divides and goes several directions.
- b) a break in the cable or shield.
- c) a change in the depth of the cable or pipe.
- d) an insulated pipe fitting.
- e) a slack loop of cable.

If you can no longer trace the path, even with the GAIN set to maximum, connect the TRANSMITTER to the far end of the path and trace back to the point where you lost the signal.

Mark the straight sections of the path every few feet. Mark sharp curves, loops, and cable bundles every few inches. Sharp changes in the path cause the RECEIVER PEAK and NULL indications to behave differently than when tracing a straight path. Practice on the path that you know has turns and laterals in it. This will help you to recognize the conditions within the field.

Null Mode Locating

Move the RECEIVER left to right across the cable path. When the RECEIVER is directly above the cable or pipe, a NULL (lowest meter reading and lowest audio tone) will occur. When moving the RECEIVER to left or right of the NULL point, the meter reading will rise to a maximum point (PEAK). The audio tone will also be at its highest pitch. When the RECEIVER is moved beyond the PEAK, the meter reading will begin to fade.

Trace the path by walking away from the TRANSMITTER at a moderate pace. Move the RECEIVER to the left and right when walking, following the NULL indications.

As you trace the path, the PEAK meter reading may slowly fade as you move away from the TRANSMITTER. Press and release the GAIN buttons as needed to compensate for changes in signal level. If the PEAK meter readings suddenly changes in level (higher or lower), one of the following may have occurred:

- a) a junction where the signal divides and goes several directions.
- b) a break in the cable or shield.
- c) a change in the depth of the cable or pipe.
- d) an insulated pipe fitting.
- e) a slack loop of cable.

If you can no longer trace the path, even with the GAIN control set to maximum, connect the TRANSMITTER to the far end of the path, and begin tracing the path back.

Mark the straight section of the path every few feet. Mark sharp curves, loops, and cable bundles every few inches. Sharp changes in the path causes the RECEIVER PEAK and NULL indicators to behave differently than when tracing a straight path. Practice on the path that you know has turns and laterals in it. This will help in recognizing the conditions within the field.

Current Measurement

The 8880 RECEIVER contains a feature that is very useful in identifying a desired cable in a field of various conductors and/or utilities. It is not unusual for the target conductor (the conductor connected to the transmitter) to induce a signal into nearby conductors in a crowded field. In these instances, the radiated signal on the conductors close to the surface of the earth, may be stronger than the TRANSMITTER signal on the target conductor buried deep in the ground. The operator will find two or more paths and must determine which is the target conductor. By using the current measurement feature of the 8880 RECEIVER, the operator can determine the amount of 815 Hz current flowing on the conductors, regardless of the depth. The highest current flow indicates the target conductor.

Begin this measurement by locating the path of the cables to be compared. Mark these locations as accurately as possible (see the sections on Peak Mode Locating and Null Mode Locating). Place the RECEIVER vertically over one of the conductor marks and rest the foot of the locator on the ground. Holding the RECEIVER vertical, press and release the CURRENT button. When the meter changes from a “thermometer” type display to a “bar” type display, hold the RECEIVER still until the measurement stabilizes. The blinking bar indicates the signal level on the cable (adjusted for depth). Next, move to the second cable and repeat the measurement. The blinking bar will show the signal level on the conductor. In addition, the previous reading is shown as a solid bar. The higher of these two readings will show which conductor is carrying the greatest locating signal.

Note:

The 8880 is designed to alert the operator of potential current measurement errors. If the display reads ‘Err’ during a current measurement, the RECEIVER has detected a condition that could produce inaccurate readings.

Errors can exist when the conductor signal flow is too small. Check TRANSMITTER hookup and far end access point for poor connections. This cause of error can be identified by a high GAIN setting (80 or greater on the bar graph display).

The RECEIVER may also be detecting adjacent cables or is not directly over the target conductor. Verifying target conductor path precisely before measuring current again.

If at anytime the display reads ‘CAL’, contact RYCOM.

Passive 50/60 Hz Locating

The 8880 RECEIVER is capable of locating power utility frequencies. This MODE is useful for locating underground primary and secondary power utilities. In certain circumstances, this MODE will also locate water pipes, sewer lines, cable television, and telephone. The reason is that common electrical grounds are sometimes found among these various utilities. Select the 50/60~ (Hz) frequency on the RECEIVER. Select PEAK mode. Locate the conductor using the PEAK mode.

This method is useful because of its speed and convenience. Start at a known reference point and keep in mind that other conductors in the area may produce this same locating signal.

The TRANSMITTER is not required to locate in this mode.

Passive Radio Frequency Locating

The 8880 RECEIVER is capable of passively locating metallic utilities where radio frequencies have coupled to the utility. This mode is useful for sweeping a green area for utilities. In certain circumstances, this mode will locate water pipes, cable television, gas lines and telephone. This locating option does not always detect buried utilities even when radio frequencies are present. This method is useful because of its speed and convenience. Start at a known reference point and keep in mind that other conductors in the area may produce this same locating signal.

The TRANSMITTER is not required to locate in this mode.

Cathodic Protection Frequency

The 8880HVDF CP RECEIVER is capable of locating the rectified signal of Cathodically Protected utilities at 120Hz. This method is useful because of its speed and convenience. Start at a known reference point and keep in mind that other conductors in the area may produce this same locating signal.

The TRANSMITTER is not required to locate in this mode.

Push Button Depth

**The only way to be sure of the depth of a utility is to expose the utility.
At any given time, the depth readout may be inaccurate.**

The 8880 RECEIVER can measure depth with the push of a button. The depth is displayed at the top of the LCD display in feet or inches (meters and centimeters if requested). Push button depth is useful in quickly determining the depth of the conductor during path locating.

Begin this measurement by locating the path of the cable or pipe. Move to the location where you want to measure the depth. Stay at least 15 feet (4.6 meters) away from the TRANSMITTER. Pin-point this location as accurately as possible (see Peak Mode Locating page 19, Null Mode Locating page 20 and Absolute Signal Strength page 21). Place the RECEIVER vertically over the conductor and rest the foot of the locator on the ground. While holding the RECEIVER vertical, press and release the DEPTH button. The RECEIVER will briefly indicate a measurement is being performed and then display the depth at the top of the LCD display.

The Absolute Signal Strength must be greater than **450** to acquire a depth reading.

Caution must be exercised when using the push button depth feature, as tilted magnetic fields and adjacent conductors can significantly influence this measurement. The operator should periodically check for adjacent conductors and tilted magnetic fields when taking push button depth readings. For information on identifying tilted magnetic fields, refer to Tilted Magnetic Field Identification and Depth Measurement 45° Method.

Depth Measurement 45° Angle Method

Move to the location you want to measure depth. Stay at least 15 feet away from the TRANSMITTER. Move the RECEIVER left to right across the path until the cable is located. Mark the path on the ground as precisely as possible using the Null Method.

Place the RECEIVER on the ground with the LCD meter facing up. Position the unit so that the BUBBLE LEVEL on top of the meter is centered (45°). Pull the RECEIVER away from the cable path (at 90° to the cable path) keeping the BUBBLE LEVEL centered. When the receiver indicates a NULL reading, mark the location of the receiver's foot. The distance between the RECEIVER and the cable path is the depth of the pipe or cable.

A false depth reading may be caused by nearby buried metallic objects, such as a second cable, pipe, sewer, fence or railroad track. Confirm the depth measurement by repeating the above steps on the opposite side of the pipe or cable.

A variance greater than 5 inches in depth measurement may indicate the presence of additional buried cables, pipes or other objects.

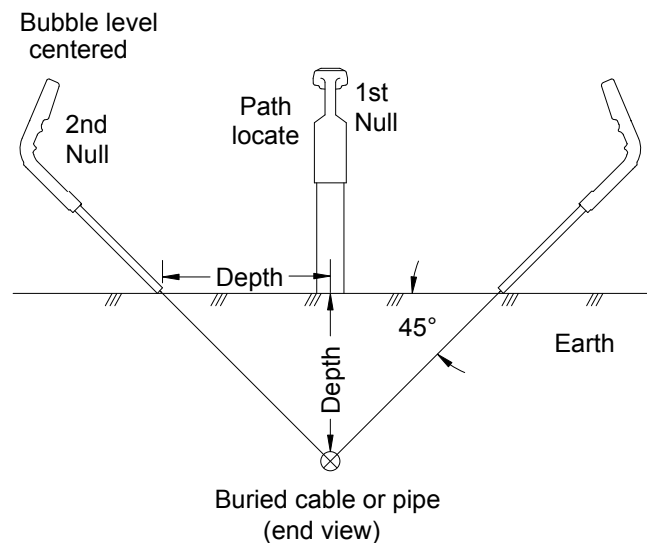

Tilted Magnetic Field Identification

When adjacent cables or pipes are present, they will sometimes create locating errors. Some of the TRANSMITTER signal is picked up by the adjacent conductors and is redirected so that it combines with the original signal. The result is a Tilted Magnetic Field. This is often the reason that numeric depth readouts are sometimes created in error.

The operator can verify the accuracy of path locate by performing the 45° Angle Method locate on both sides of the cable path. If the right and left side depth readings agree to within 5 inches, the path locate is accurate. If the two depth readings do not agree, then **dig with care**. A closer locate would be halfway between the two outside depth locate marks.

This is an important technique that should be used to ensure the most accurate location possible.

STAFF Receiver Controls and Indicators

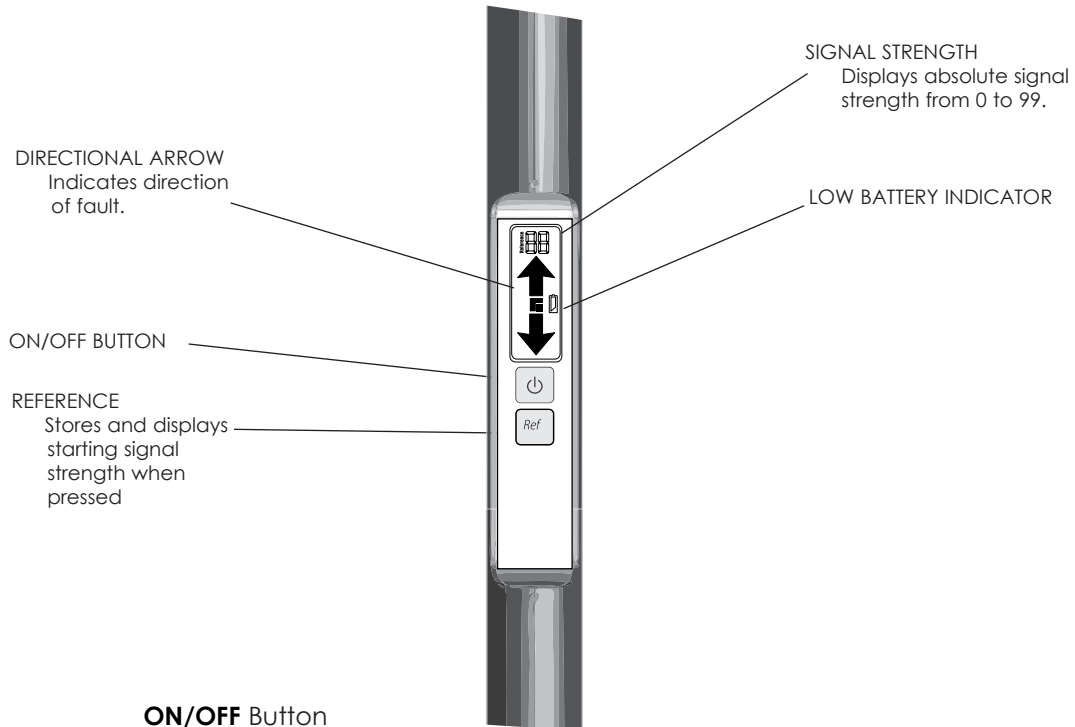

ON/OFF Button
Turns the unit on and off.

REFERENCE Button
When pressed it stores the signal strength and sets the reference mode. The tone will beep more rapidly as the STAFF detects a similar signal strength. Pressing the reference button again (after a reference has been taken) will display the original reference reading for 2 seconds. Turn the unit off and on to clear the reference.

DIRECTIONAL ARROW
After proper synchronization the arrows will direct the user to the fault. If the signal strength drops completely off in the area between the ground rod and the fault, the arrows will not properly display direction until the unit comes within range of the fault or ground rod.

SIGNAL STRENGTH
The Signal Strength is displayed in a value from 0 to 100. The closer to the ground rod and/or the fault will result in the highest reading. The signal strength may drop completely off in the area between the ground rod and the fault.

LOW BATTERY
The **STAFF** Locator will indicate low battery condition by displaying the Low Battery icon on the LCD screen.

Fault Locating with the 8880 HVDFP or STAFF

Fault locating determines the position of an insulated break on an underground conductor. Some signal will return to the TRANSMITTER via the GROUND ROD through a break in the insulation.

It is generally a good idea to locate the conductor path before attempting to fault locate. If, during the path locate, an unusual amount of signal loss occurs, a part of the signal has escaped to ground in the last several feet. Lower frequencies will generally show a greater signal loss at a fault, but higher frequencies may be needed to locate if resistance is too high.

Note: Signal would go to ground at a grounded splice point, which would act as a fault during the path and fault locate.

Once the path is determined and a general area where a fault is expected, additional current can be forced to flow through the fault by disconnecting and isolating the FAR ACCESS POINT. If the current has no path to ground at the FAR ACCESS POINT, it will be forced to seek ground at the fault. This will increase the current in the soil at the fault and ease the detection of the fault.

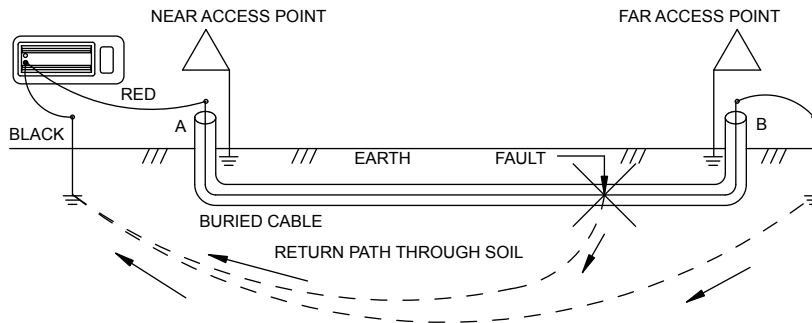

Set the Transmitter to FAULT MODE by pressing and holding the FREQUENCY BUTTON for 10 SECONDS. When released the **DFF** symbol on the LCD will be displayed.

Place the A-frame connected to the receiver (or **STAFF**) into the ground between the ground rod and the fault with the FRONT SPIKE toward the fault and the BACK SPIKE toward the ground rod (APPROX 2 YARDS OR 2 METERS FROM GROUND ROD).

Turn the receiver on. **The RECEIVER LCD SHOULD INDICATE DFF FOR FAULT MODE. PRESS THE MODE BUTTON TO TOGGLE OUT OF DFF MODE AND CYCLE BACK TO DFF MODE.** This will sync the receiver to the transmitted signal. As you walk the path using the GRP, place the probe every three or four steps. The bar graph will indicate the direction of the fault by blinking at the top for forward and the bottom for backward. The STAFF will blink the appropriate arrow. As you near an area of high current concentration in the soil, the GROUND ROD or the fault, the center bars of the bar graph will blink faster or stay on. The fault lies in the center of the GROUND RETURN PROBE spikes.

Ground Return Probe Insertion

Circuitry between the ground spikes provides a path for current in the soil returning to the GROUND ROD. The current enters one spike of the GROUND RETURN PROBE and exits the other spike. The GRP should be inserted into the soil with consistent force and depth.

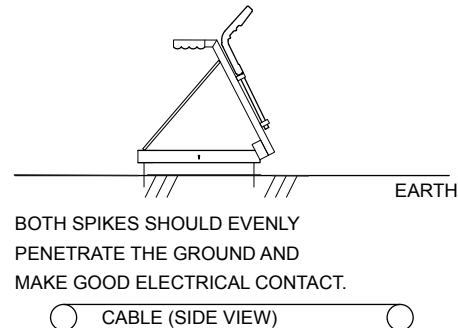
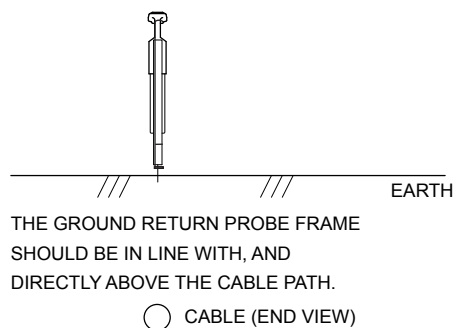

Fault Locating with the 8880 HVDF or STAFF

- Locate path of faulted conductor
- Remove power from faulted conductor
- Disconnect loads and ground from both ends of target conductor and neighboring conductors

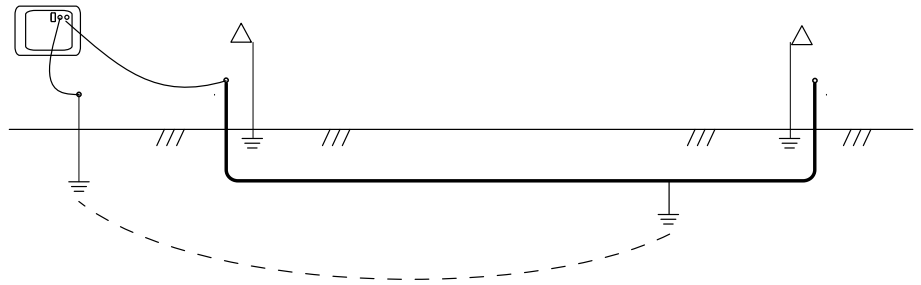

- With transmitter off connect red lead to the faulted conductor and black lead to independent ground rod
- Turn the transmitter on and set to DFF Mode
- Complete transmitter instruction before using GRP
- Place GRP or STAFF in soil with back spike approx. 2 yards (2 meters) from ground rod and front spike toward suspected fault
- Turn receiver on (for proper synchronizing spikes must be in the ground before turning the unit to DFF mode.)
- (8880 HVDF only) With the GRP plugged in the unit will automatically set to DFF mode. Using the mode button toggle the mode out of DFF and then through the modes until DFF is displayed again on LCD. This synchronizes the unit.
- Note numeric reading as reference to signal strength near fault
- LCD will indicate fault direction

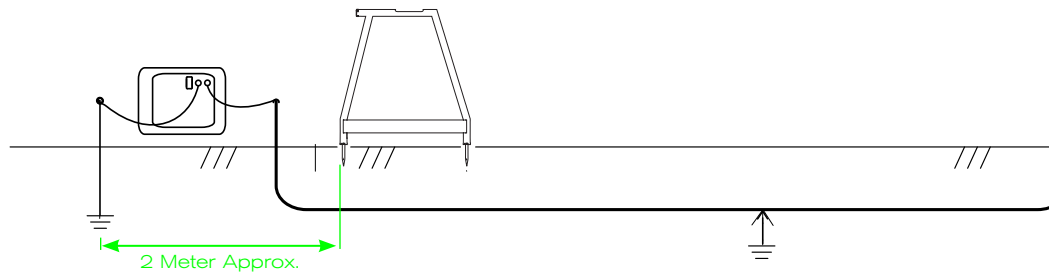

- Signal strength will fall as leaving the ground spike until passing the half-way point between ground spike and fault. Signal will start to rise from half-way point to fault. If the distance is great the signal strength may fall to non-detectable level and arrows may not stabilize through the center section.
- Any synchronizing must be done near the ground rod with the spike in the ground before turning the unit to DFF mode (or turning the STAFF on).

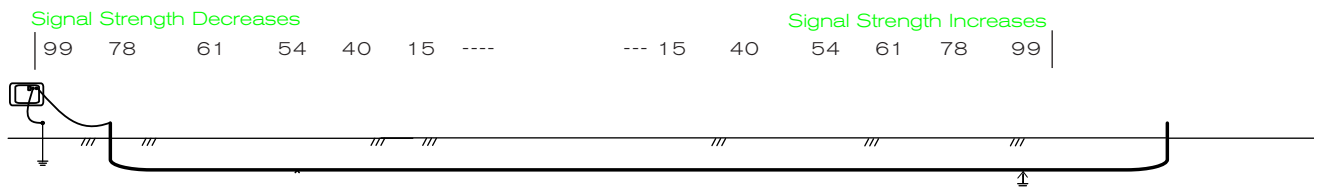

Faults Beneath Paved Surfaces

A potential problem could exist if a fault should lie beneath a paved surface. In this case, the GROUND RETURN PROBE or STAFF will be used in the dirt at the side of the paved area. Since the return current in the soil begins its return from the fault - like the spokes of a wheel laying on the ground - equal amounts of current will enter the GRP if it is placed on the ground and positioned broadside to the fault. At the point where the directional indication changes the fault will lie on a straight line projected at a right angle from the center of the GRP. The GRP adjustments can be made by slightly rotating the GROUND RETURN PROBE to find the directional change. The operator should record this line over the paved area. By repeating this procedure from another location near the paved area, another line will be produced. The intersection of the two lines is the location of the fault.

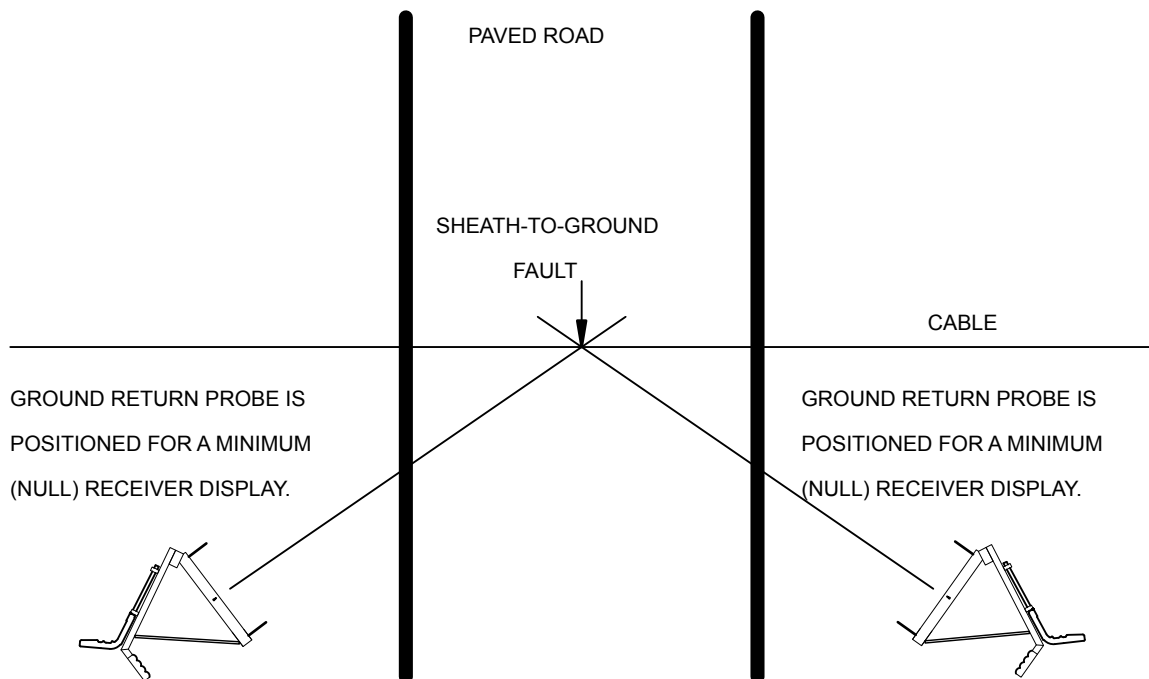

8880HVDFF Specifications

Transmitter

Operating Frequency	82 kHz • 33kHz • 8 kHz • 815 Hz • 4Hz pulse
Operating Temperature	-4°F to 133° (-20°C to +55°C)
Hook-up Method	Direct Connection Inductive Coupling (with optional coupler) Transmitter Induction
Load Matching	automatic from 5 Ω to 20,000 Ω
Output Power	5 Watts (High) 250 Milliwatts (Low)
Output Power DFF	100 volts to 1200 volts
Battery Types	12 V, 7 amp-hour maintenance free sealed lead acid battery
Battery Life	greater than 30 hours*
Dimensions	16" x 6.32" x 6"
Weight	11.5 lbs (5kg)

*depending on load, frequency and power setting

8880PLS & 8879PLS Receiver Specifications

Operating Frequency	82 kHz • 33kHz • 8 kHz • 815 Hz • 50/60~ • RF (4Hz Input Via GRP 8880 HVDFF ONLY)
Antenna Mode	Null (vertical coil) • Peak (horizontal coil)
Audio Indication	Variable pitch audio
Operating Temperature	-4°F to 133° (-20°C to +55°C)
Battery Type	6 - "C" Duracell alkaline batteries
Battery Life	Continuous Intermittent
	40 hours 82 hours (10 minute auto shut off)
Dimensions	30.3" x 3.75" x 9.4"
Weight	3 pounds
Signal Strength	LCD bar graph Absolute Signal Strength readout 0-999
Gain Control	up/down button for automatic centering and manual control
Dynamic Range	126 dB
Depth Measurement	Automatic Manual
	Digital depth readout to 15 feet (feet/ inches & metric) Triangulation for verification of automatic readout in congested environments

STAFF Specifications STAFF GROUND RETURN PROBE

Operating Frequency	4HZ
Connection Mode	Ground Probes
Audio Indication	Variable pitch audio
Operating Temperature	-4°F to 133° (-20°C to +55°C)
Battery Type	6 - "AA" Duracell alkaline batteries
Battery Life	Continuous Intermittent
	40 hours 82 hours
Dimensions	30.3" x 23.75" x 3"
Weight	3 pounds
Signal Strength	LCD bar graph Absolute Signal Strength readout 0-99

Factory Service

If your 8880 Locator is not working properly, first call RYCOM Instruments, Inc. Tech Support at **+1-816-353-2100** or email **repair@rycominstruments.com** for assistance. If the locator is in need of repair, **Sales Support** will provide instructions for sending your locator to the closest factory approved service center. The instrument will be repaired and shipped back or you will be advise if the instrument is un-repairable.

Note: There is a minimum charge for repair and handling.

Warranty

THIS INSTRUMENT IS UNDER WARRANTY FOR ONE YEAR FROM THE DATE OF DELIVERY AGAINST DEFECTS IN MATERIAL AND WORKMANSHIP **(EXCEPT BATTERIES)**. WE WILL REPAIR OR REPLACE PRODUCTS THAT PROVE TO BE DEFECTIVE DURING WARRANTY PERIOD.

THIS WARRANTY IS VOID IF, AFTER HAVING RECEIVED THE INSTRUMENT IN GOOD CONDITION, IT IS SUBJECTED TO ABUSE, UNAUTHORIZED ALTERATIONS OR CASUAL REPAIR.

NO OTHER WARRANTY IS EXPRESSED OR IMPLIED. THE WARRANTY DESCRIBED IN THIS PARAGRAPH SHALL BE IN LIEU OF ANY OTHER WARRANTY, INCLUDING BUT NOT LIMITED TO, ANY IMPLIED WARRANTY OF MERCHANTABILITY OR FITNESS FOR A PARTICULAR PURPOSE. WE ARE NOT LIABLE FOR CONSEQUENTIAL DAMAGES.

Parts List

8880 HVDF PACKAGE

RECEIVER (8880PLS RCVR -00 60Hz; -01 50Hz)	001-00376-00
TRANSMITTER (RECHARGEABLE)	001-00377-00
GROUOND RETURN PROBE (8880 A-FRAME)	001-00214-00
USER'S MANUAL	030-00085-00
LOCATING BASICS VIDEO	035-00001-00
RED/BLACK CORD(LARGE CLAMP)	151-00078-00
GROUND ROD	211-00032-00
AC CHARGER (RECHARGEABLE TRANSMITTER ONLY)	750-00023-00
AC CHARGER 230 VOLT	750-00024-00
DC CHARGER	750-00006-00

8880 HVDF PACKAGE

RECEIVER (8879PLS RCVR -00 60Hz; -01 50Hz)	001-00322-00
STAFF RECEIVER	001-00301-00
TRANSMITTER (RECHARGEABLE)	001-00377-00
USER'S MANUAL	030-00085-00
LOCATING BASICS VIDEO	035-00001-00
RED/BLACK CORD(LARGE CLAMP)	151-00078-00
GROUND ROD	211-00032-00
AC CHARGER (RECHARGEABLE TRANSMITTER ONLY)	750-00023-00
AC CHARGER 230 VOLT	750-00024-00
DC CHARGER	750-00006-00

8880 ACCESSORIES

HARD INDUCTIVE CLAMP(82kHz)	100-00243-00
HARD INDUCTIVE CLAMP (82kHz/8kHz)	100-00244-00
FLEXICOUPLER (815Hz/ 82kHz)	100-00245-00
FLEXICOUPLER (82KHz/ 8KHz)	100-00166-00
815Hz SEWER SONDE	001-00281-01
33K SEWER SONDE	001-00281-02
8K SEWER SONDE	001-00281-04
815Hz DUCT PROOFING SONDE	001-00144-00
HEADSET	743-00013-00